

GOODWIN®

SUBMERSIBLE PUMPS AUSTRALIA

Submersible Slurry Pumps & High Head Dewatering Pump

Number One for Reliability,
Strength & Endurance



Submersible Slurry Pumps

Goodwin Submersible Slurry Pumps are designed and precision engineered to endure and perform in the most demanding environments.

The heavy duty pumps are equipped with a patented external inducer that breaks down and re-suspends settled or compacted solids, allowing them to easily transfer a very high percentage of solids to water.

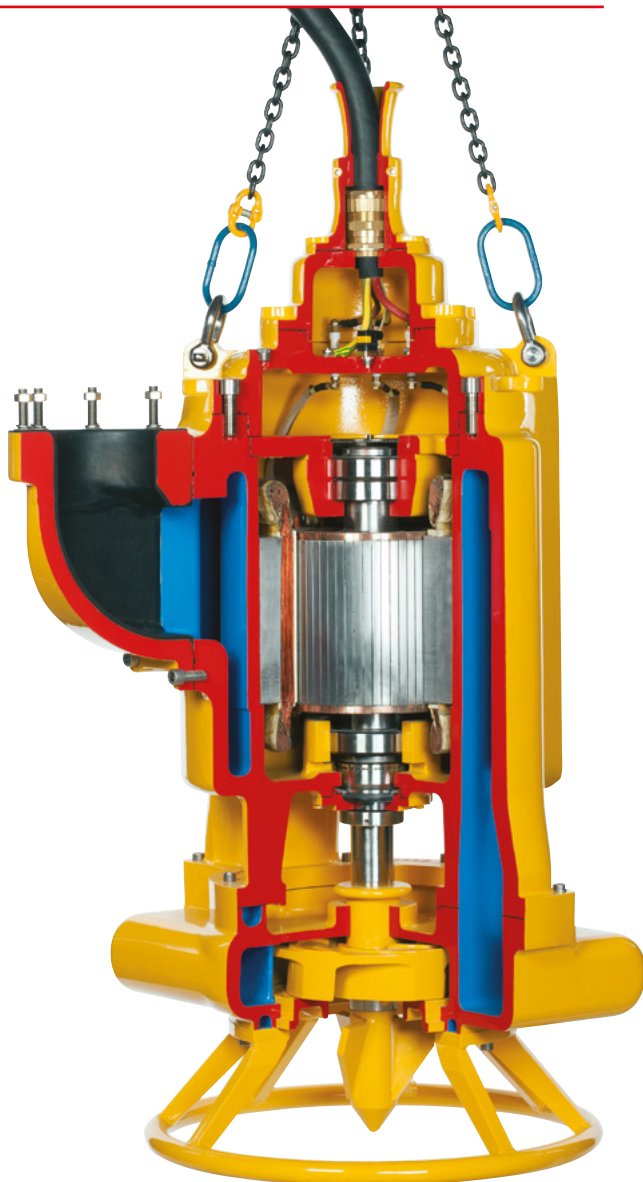

Goodwin have designed and manufactured Submersible Slurry Pumps for over thirty years.

The original design brief included a formidable list of criteria:

- A motor enclosure which eliminated electrical motor heating and burnout.
- A motor with reserves of power to enable direct online starting when in settled sump solids.
- Design an integral inducer to break down and re-suspend settled solids.
- Develop a mechanical sealing system which was not subjected to the pumped media pressure.
- Create a cable gland entry and motor configuration which kept the terminal enclosure separate from the motor enclosure.

Originally used in UK coal mining, this was soon followed by the steel and power industries. During the 1990s a major design review took place before expanding into Europe and beyond, with applications in Gold, Copper and Platinum mining.

Goodwin Pumps are now sold on four continents with centres of excellence for sales and service in Europe, India, China, Brazil, South Africa and Australia.

...pioneering construction features
allow for total operation in fully,
part or non-submerged conditions



	100 NZE	100 ANZE®	100 HNZB	150 NZE	150 ANZE®	150 HNZB	200 NZE	200 ANZE®	200 HNZB
Max solid content	65%	65%	25%	65%	65%	40%	65%	65%	40%
Max specific gravity kg/l	2.8	2.8	1.5	2.5	2.1	1.5	2.5	2.1	1.5
Max particle size	25mm	32mm	12mm	30mm	35mm	20mm	40mm	40mm	22mm
Max slurry temperature	90°C	90°C	90°C	90°C	90°C	90°C	90°C	90°C	90°C
Max flow m ³ /hr	137	220	160	380	500	290	600	800	800
Max head (pressure bar)	33m (3.3 bar)	38m (3.8 bar)	60m (6 bar)	25m (2.5 bar)	40m (4 bar)	62m (6.2 bar)	27m (2.7 bar)	40m (4 bar)	55m (5.5 bar)
Max submergence depth	28m	28m	28m	28m	28m	28m	28m	28m	28m
Minimum sump size based on pump dimensions* (length x width x depth)	(l) 2m (w) 1.5m (d) 2m	(l) 2m (w) 1.5m (d) 2m	(l) 2m (w) 1.5m (d) 2m	(l) 2.5m (w) 2m (d) 2.5m	(l) 2.5m (w) 2m (d) 2.5m	(l) 2.5m (w) 2m (d) 2.5m	(l) 3m (w) 2.5m (d) 3m	(l) 3m (w) 2.5m (d) 3m	(l) 3m (w) 2.5m (d) 3m
Sump Dead Zone* (Bottom)	0.35m	0.35m	0.35m	0.4m	0.4m	0.4m	0.45m	0.45m	0.45m

* See page I3 for more information

Features that make Goodwin Number One

Goodwin heavy duty pumps are equipped with outstanding features that guarantee advanced performance over less durable pumps, with pioneering construction that allows for total operation in fully, part or non-submerged conditions.



Twin Volute Casing

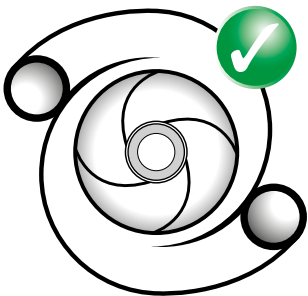

Goodwin use a 'Twin Volute' casing which puts a balanced load on the shaft which leads to much longer mechanical seal and bearing life as standard.

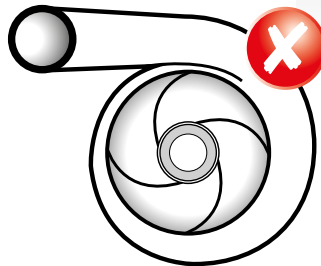

Competitors 'Single Volute' casing puts an uneven load on the Shaft, which often leads to premature mechanical seal and bearing failure.

Inducer Effect

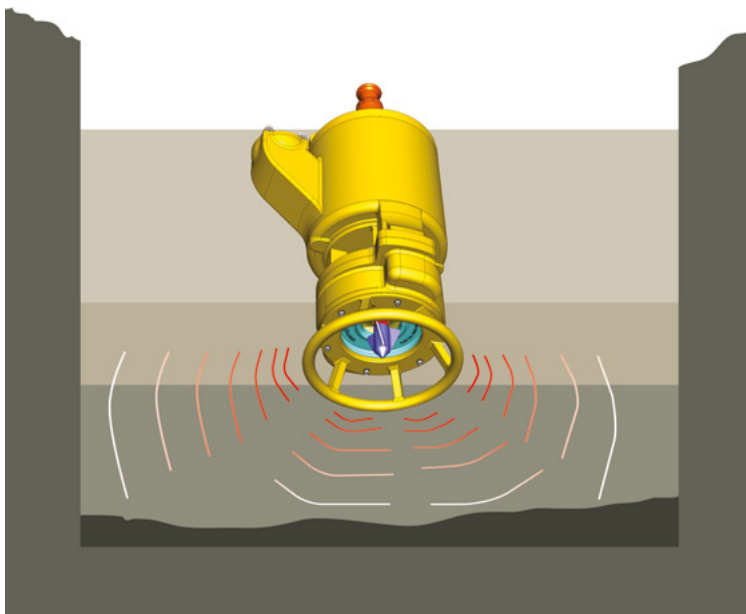

The patented Goodwin Inducer sends hydrodynamic shock waves below the pump which makes settled solids start to flow.

Removable Discharge Elbow

The 150 and 200mm Goodwin Pumps are supplied with a removable discharge elbow, which is rubber lined for improved abrasion resistance.

Non-Pressurised Mechanical Seal

Suitable for submergence depth up to 28 metres. The Goodwin mechanical seal is only subjected to the pressure from the submergence depth of the pump which generally is only a few metres of head and not the discharge pressure of the product as competitor pumps predominantly are. This greatly reduces the chance of fluid ingress into the motor itself and the destructive consequences which can result. The seal is positioned directly below the lower bearing to give it maximum support and protection from vibration.

Heavy Duty Wet-End Parts

For very abrasive applications Goodwin can offer tungsten carbide coated impellers, inducers and wear plates as it is possible to coat 100% of the surface exposed to the slurry and thus provide the customer with excellent component life. Competitors closed vane designs have hidden surfaces which can't be tungsten carbide coated.

Open Vane Impeller

This feature assists the breakdown of large particles in the impeller that might ultimately lead to a blocked pump. There is little if any chance of the impeller becoming blocked as opposed to closed vane impellers which are often blocked and tend to stay blocked.

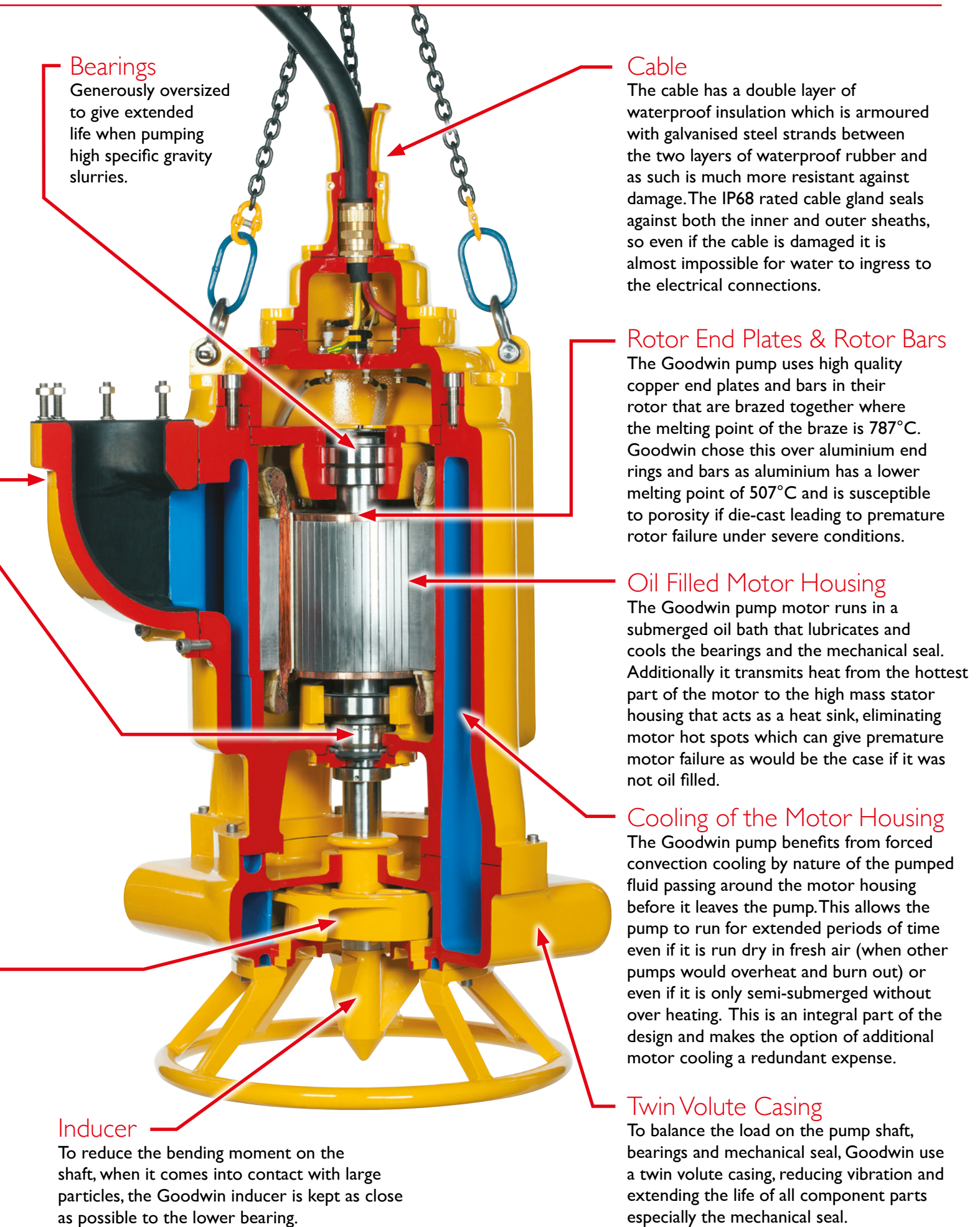

Bearings

Generously oversized to give extended life when pumping high specific gravity slurries.

Cable

The cable has a double layer of waterproof insulation which is armoured with galvanised steel strands between the two layers of waterproof rubber and as such is much more resistant against damage. The IP68 rated cable gland seals against both the inner and outer sheaths, so even if the cable is damaged it is almost impossible for water to ingress to the electrical connections.

Rotor End Plates & Rotor Bars

The Goodwin pump uses high quality copper end plates and bars in their rotor that are brazed together where the melting point of the braze is 787°C. Goodwin chose this over aluminium end rings and bars as aluminium has a lower melting point of 507°C and is susceptible to porosity if die-cast leading to premature rotor failure under severe conditions.

Oil Filled Motor Housing

The Goodwin pump motor runs in a submerged oil bath that lubricates and cools the bearings and the mechanical seal. Additionally it transmits heat from the hottest part of the motor to the high mass stator housing that acts as a heat sink, eliminating motor hot spots which can give premature motor failure as would be the case if it was not oil filled.

Cooling of the Motor Housing

The Goodwin pump benefits from forced convection cooling by nature of the pumped fluid passing around the motor housing before it leaves the pump. This allows the pump to run for extended periods of time even if it is run dry in fresh air (when other pumps would overheat and burn out) or even if it is only semi-submerged without over heating. This is an integral part of the design and makes the option of additional motor cooling a redundant expense.

Inducer

To reduce the bending moment on the shaft, when it comes into contact with large particles, the Goodwin inducer is kept as close as possible to the lower bearing.

Twin Volute Casing

To balance the load on the pump shaft, bearings and mechanical seal, Goodwin use a twin volute casing, reducing vibration and extending the life of all component parts especially the mechanical seal.

Submersible Slurry Pump Range

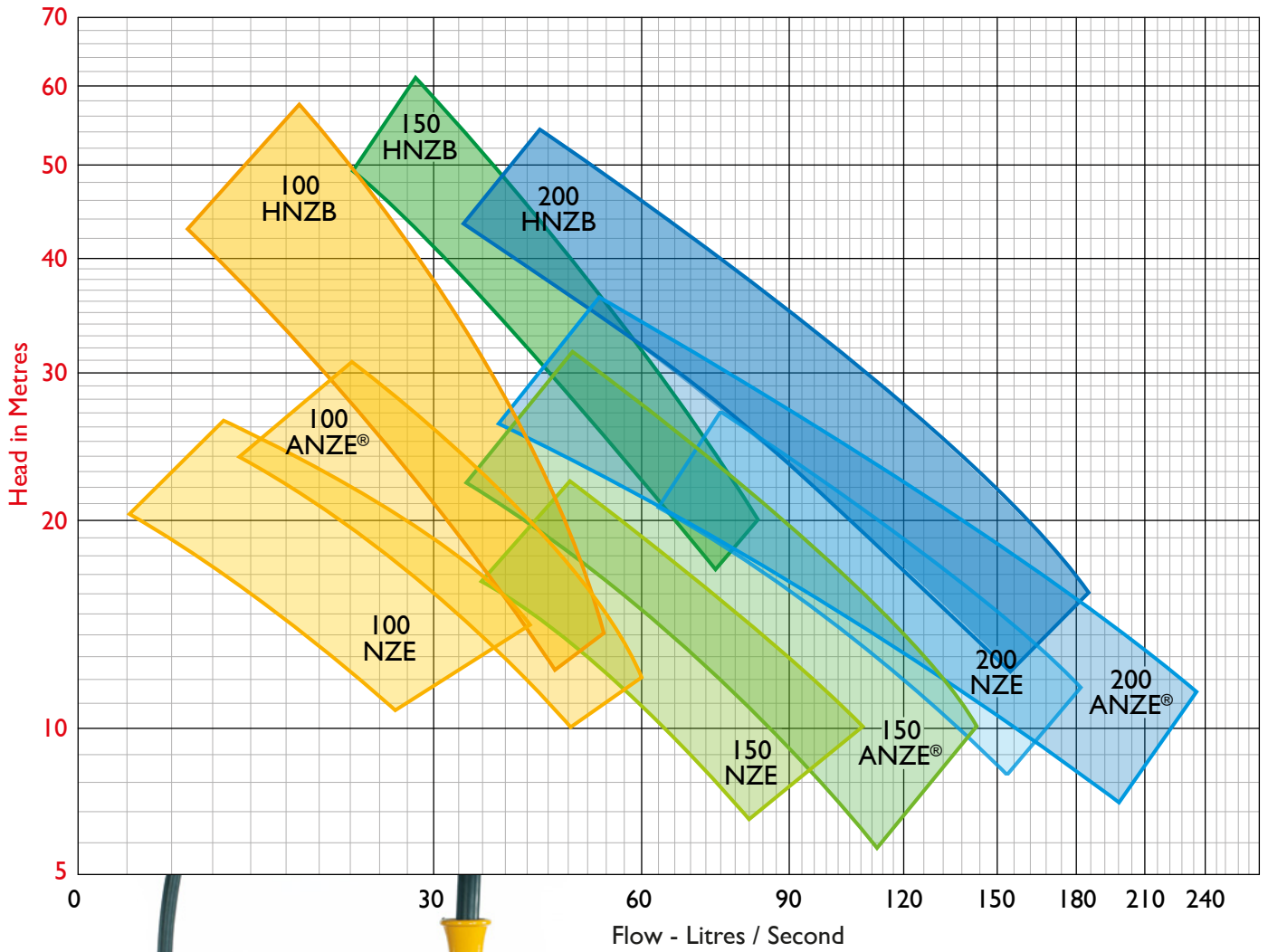

100 ANZE®

200 ANZE®

100mm Pump Curves

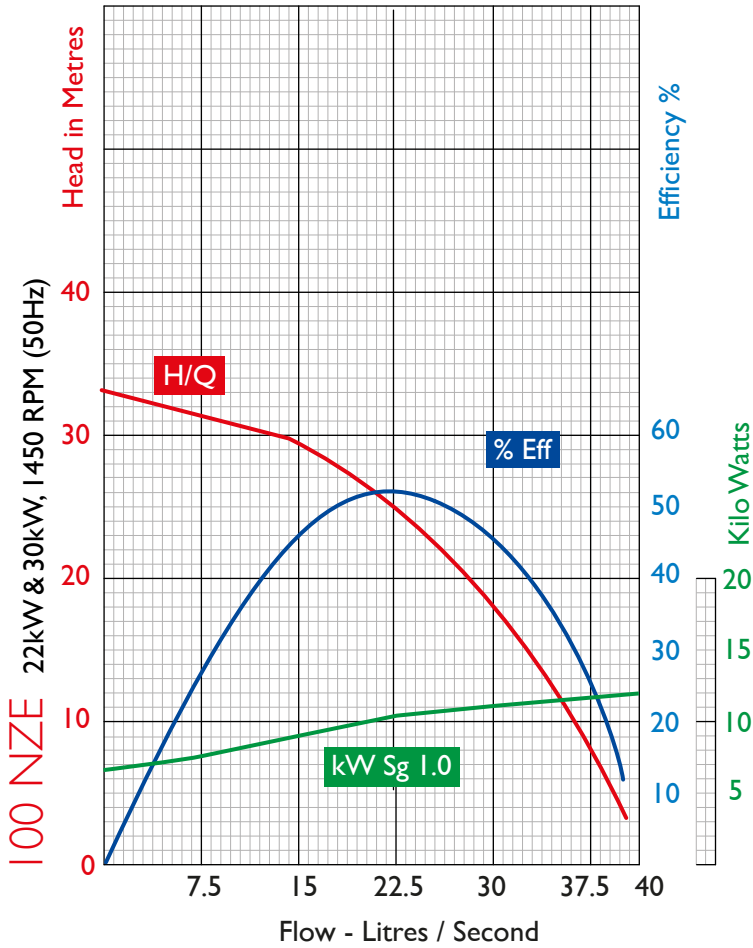

Electrical Data

Volts	Full Load Current	Inrush Current Direct on line	No Load Current	Fuse Size (HRC)
-------	-------------------	-------------------------------	-----------------	-----------------

30kW, 1450RPM - 100mm NZE, ANZE & HNZB

380V	58 A	300 A	14 A	100 A
415V	54 A	280 A	13 A	100 A
525V	42 A	220 A	10 A	100 A
660V	33 A	170 A	8 A	80 A

22kW, 1450RPM - 100mm NZE ONLY

380V	41 A	215 A	11 A	80 A
415V	38 A	200 A	10 A	80 A
525V	30 A	155 A	8 A	60 A
660V	23 A	120 A	6 A	60 A

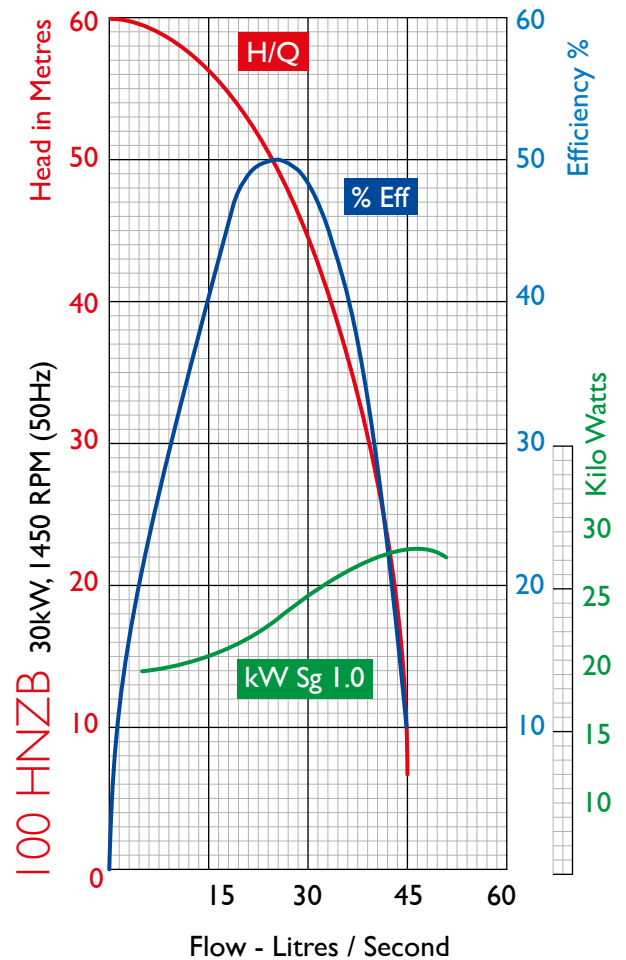
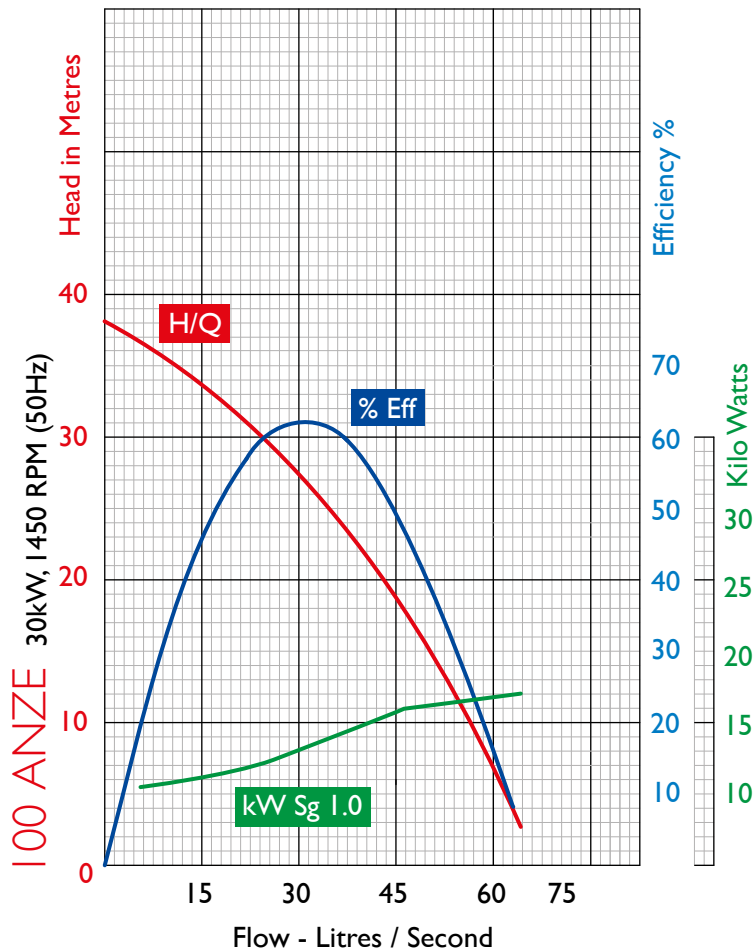

150mm Pump Curves

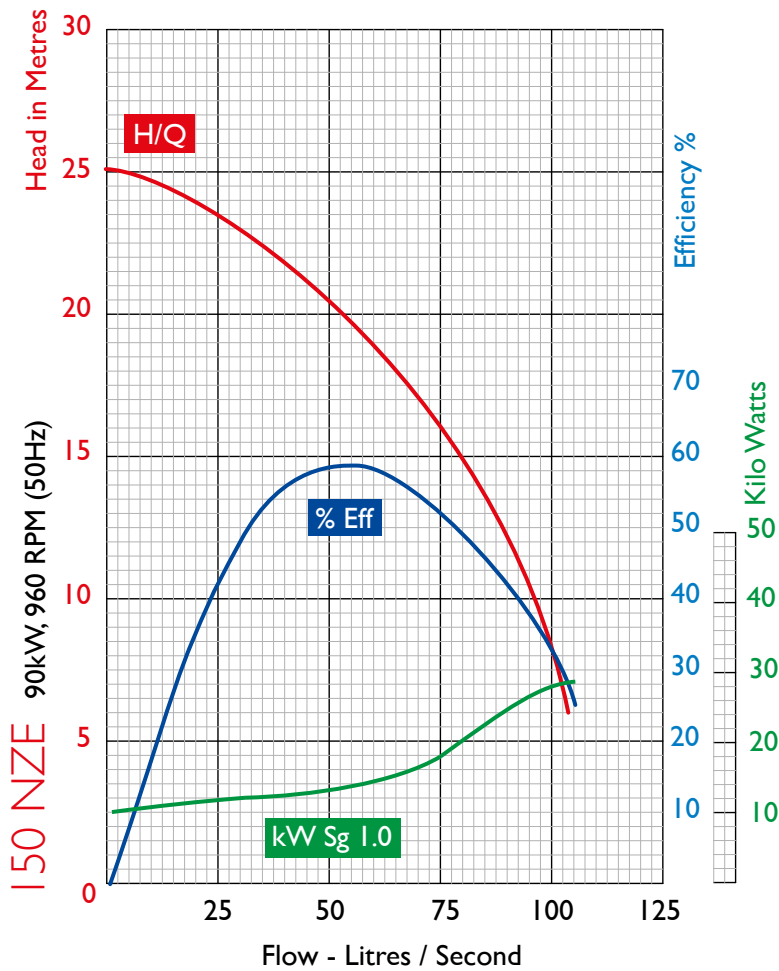

Electrical Data

Volts	Full Load Current	Inrush Current Direct on line	Inrush Current Soft Start	No Load Current	Fuse Size (HRC)
-------	-------------------	-------------------------------	---------------------------	-----------------	-----------------

90kW , 960RPM - 150mm NZE & ANZE

380V	171 A	890 A	600 A	40 A	350 A
415V	160 A	830 A	560 A	38 A	350 A
525V	128 A	665 A	450 A	30 A	300 A
660V	97 A	500 A	335 A	23 A	300 A

90kW , 1450RPM - 150mm HNZZ

380V	165 A	860 A	580 A	39 A	350 A
415V	156 A	810 A	545 A	37 A	350 A
525V	124 A	645 A	435 A	29 A	300 A
660V	94 A	490 A	330 A	22 A	300 A

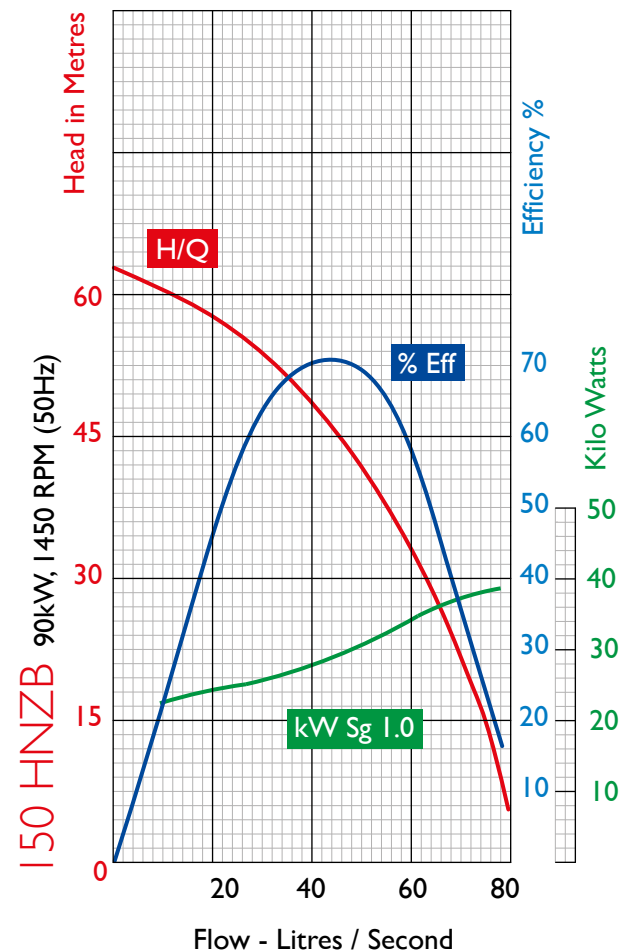
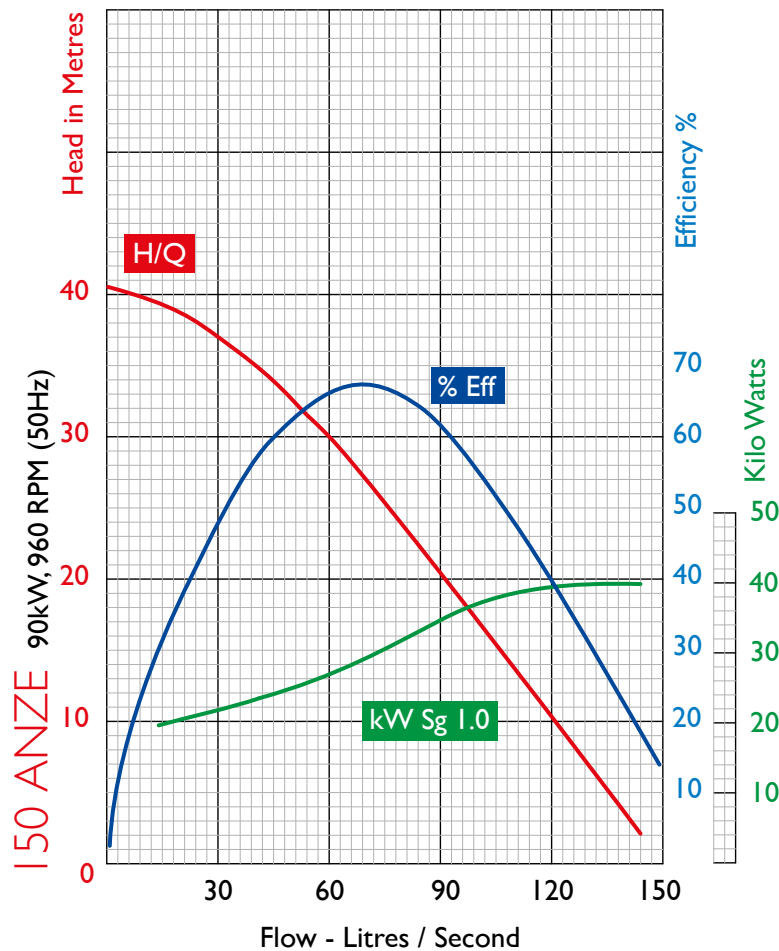

200mm Pump Curves

200 NZE 112kW, 960 RPM (50Hz)

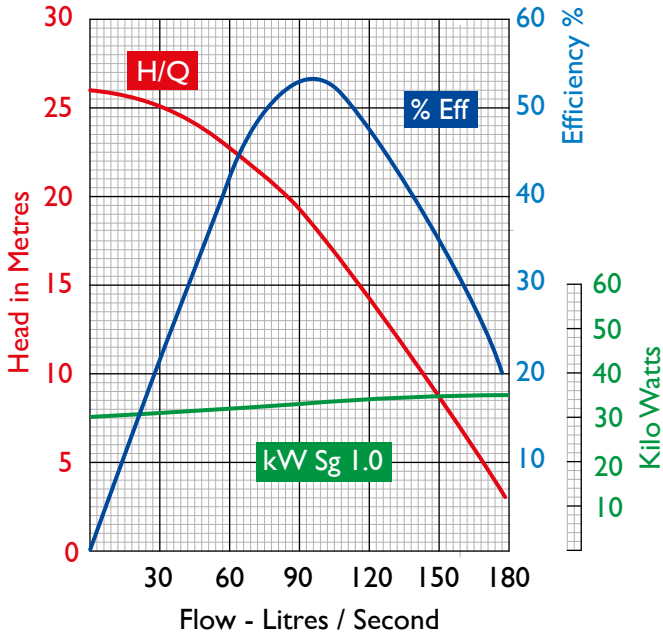

200 ANZE 112kW, 960 RPM (50Hz)

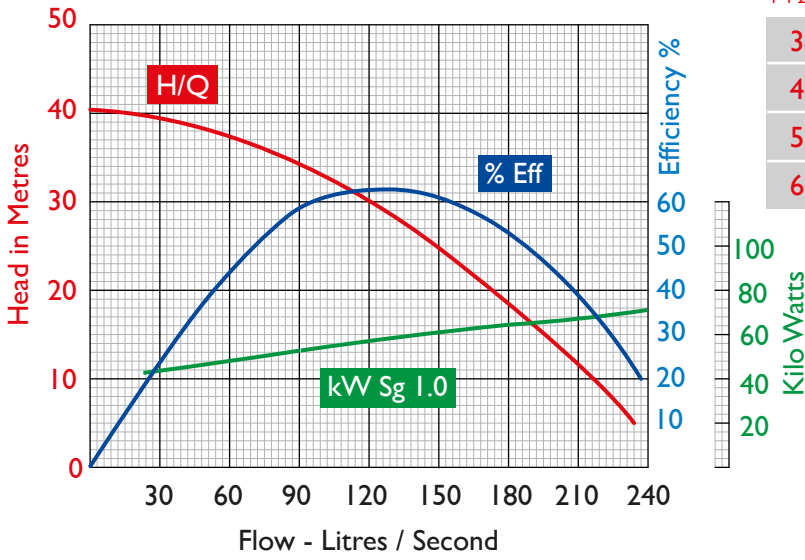

200 HNZZ 112kW, 1450 RPM (50Hz)

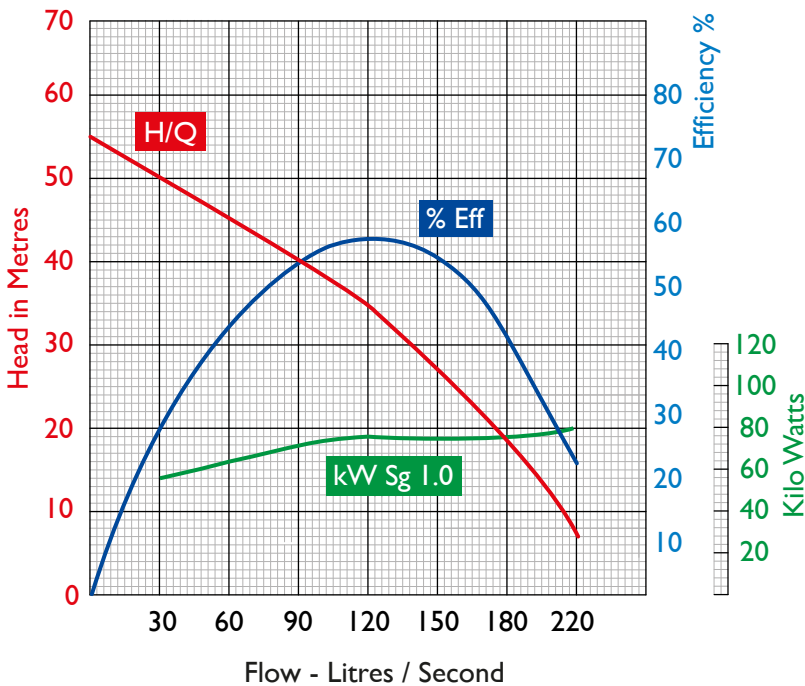

Electrical Data

Volts	Full Load Current	Inrush Current Direct on line	Inrush Current Soft Start	No Load Current	Fuse Size (HRC)
-------	-------------------	-------------------------------	---------------------------	-----------------	-----------------

112kW, 960RPM - 200mm NZE & ANZE

380V	210 A	1120 A	735 A	52 A	400 A
415V	190 A	1030 A	665 A	48 A	400 A
525V	150 A	840 A	530 A	39 A	350 A
660V	120 A	655 A	420 A	30 A	300 A

112kW, 1450RPM - 200mm HNZZ

380V	200 A	1065 A	700 A	50 A	400 A
415V	185 A	960 A	650 A	47 A	400 A
525V	145 A	745 A	510 A	37 A	350 A
660V	115 A	565 A	400 A	28 A	300 A



Pump Selection Graphs

Static Head - This is the vertical height from the surface of the slurry to the point of discharge.

Friction Head - Friction losses occur when pumping slurry through the discharge line, valves and fittings. This is known as 'Friction Head', and needs to be converted from equivalent length of pipe to pumped head (in metres).

Total Dynamic Head (TDH) - This is the 'Static Head' added to the 'Friction Head' then converted into metres.

Pipeline Critical Velocity - The velocity of flow in the pipeline must be kept above a certain minimum value to prevent solids from settling out and blocking the pipe. This velocity can vary between different types of slurry, depending on the Specific Gravity (Sg) of the slurry being pumped. It is also important to remember that whilst it is essential to maintain a minimum velocity, having a velocity that is too high will also create problems such as high friction losses and increased wear on the piping system.

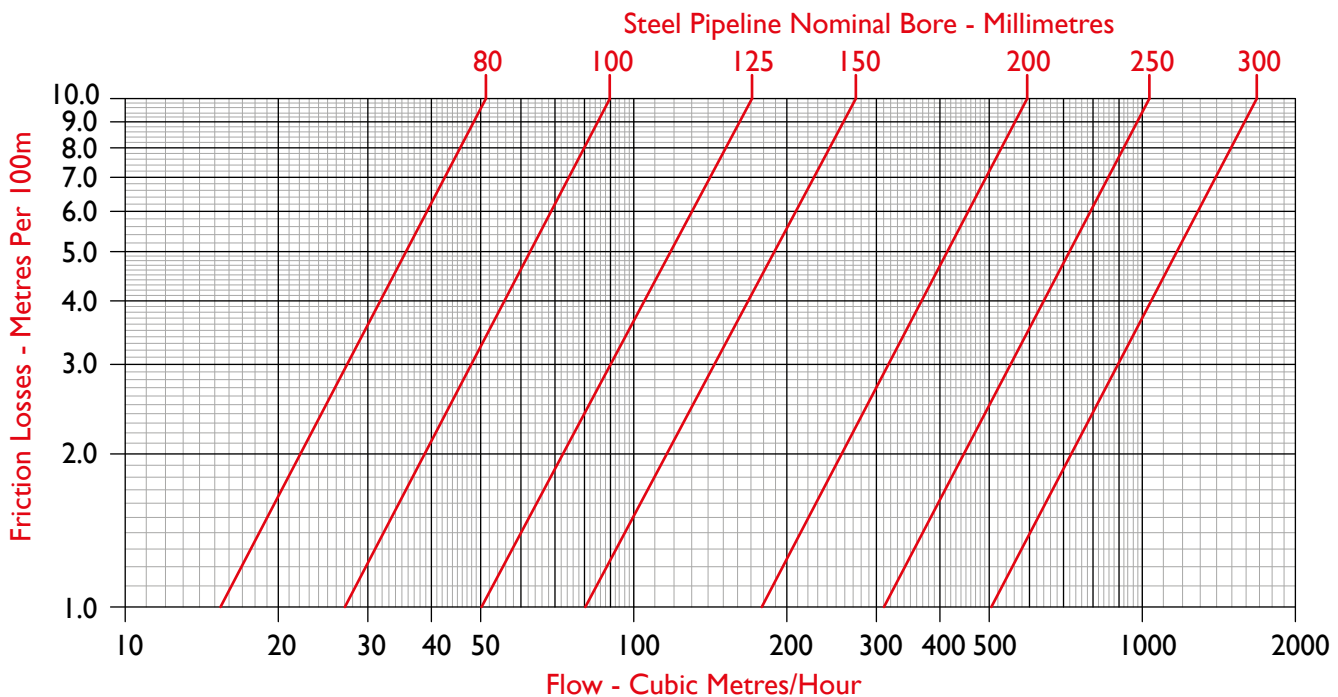
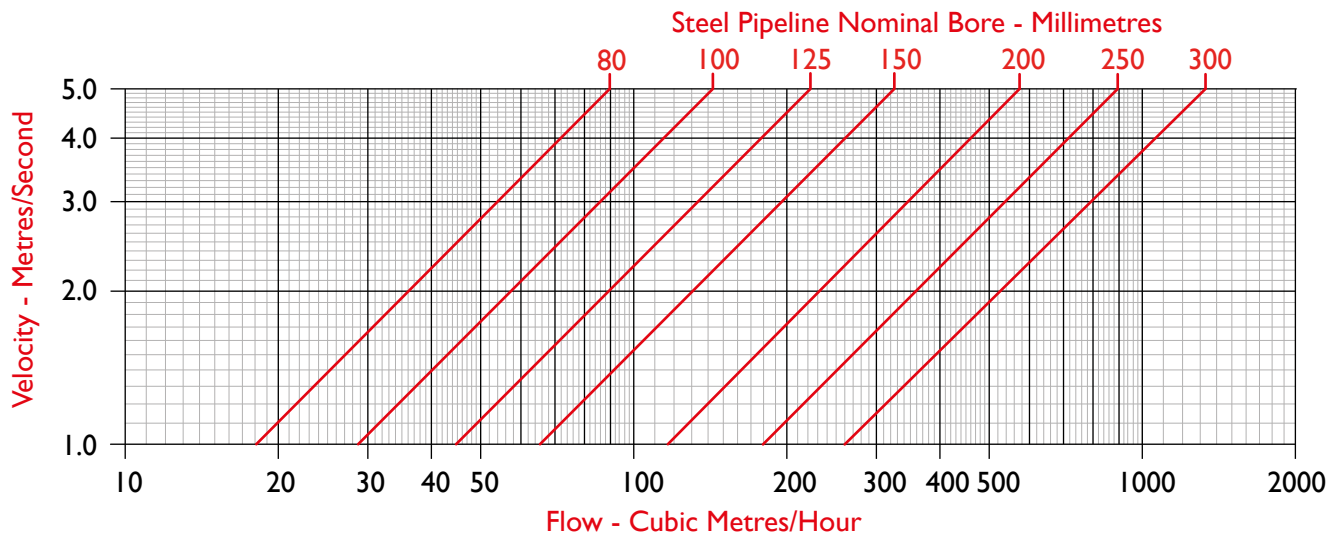
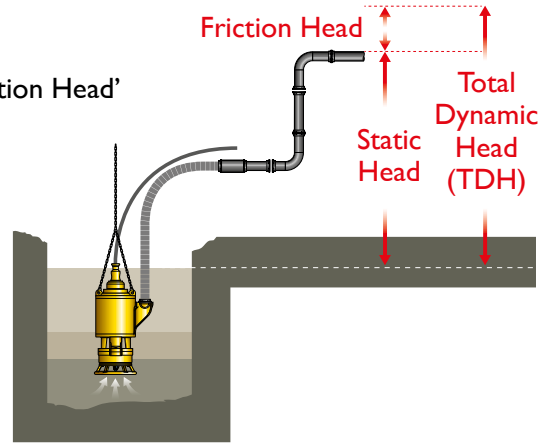

Typical Weights of Dry Materials and Advisable Pipeline Velocities

Material	Density (Sg) Mined	Density (Sg) Processed	Advisable Minimum Pipe Velocity	Advisable Maximum Pipe Velocity
Ash	N/A	0.7 - 1.2	1.5 m/Sec	5 m/Sec
Bauxite	1.8 - 2.5	2.6 - 2.8	2 m/Sec	5 m/Sec
Coal	1.1 - 1.5	1.4 - 1.8	2 m/Sec	5 m/Sec
Copper	1.9 - 4.3	8.8 - 9.0	2 m/Sec	5 m/Sec
Fluorspar	1.7 - 2.9	3.1 - 3.3	2 m/Sec	5 m/Sec
Gold	2.4 - 2.8	19.2 - 19.3	2 m/Sec	5 m/Sec
Iron	2.1 - 5.5	7.0 - 7.9	2 m/Sec	5 m/Sec
Lead	7.3 - 7.6	11.3 - 11.4	2.5 m/Sec	5 m/Sec
Magnetite	2.1 - 5.0	4.9 - 5.2	2 m/Sec	5 m/Sec
Mill scale	N/A	2.2 - 8.2	2.5 m/Sec	5 m/Sec
Platinum	2.6 - 3.4	21.4 - 21.5	2 m/Sec	5 m/Sec
Sand	1.2 - 1.4	2.6 - 2.7	2 m/Sec	5 m/Sec
Shale	1.5 - 2.0	2.6 - 2.9	2 m/Sec	5 m/Sec
Slag (furnace)	N/A	2.5 - 3.0	2 m/Sec	5 m/Sec
Zinc	3.9 - 4.2	6.9 - 7.2	2 m/Sec	5 m/Sec

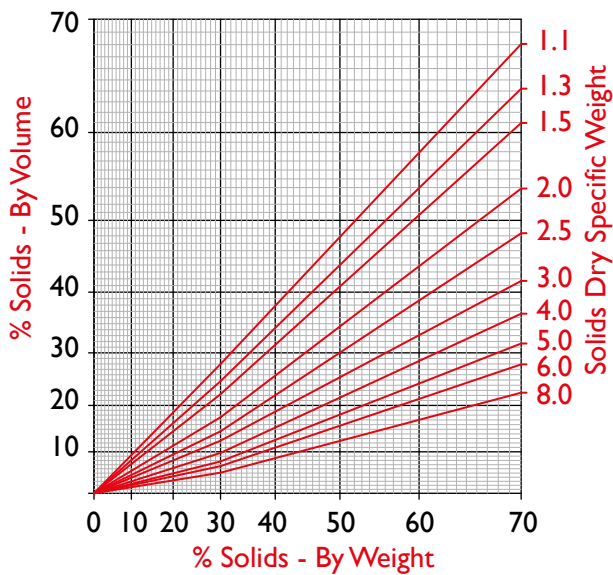

Pipe Diameter	90° Elbow	90° Swept Bend	Gate Valve	Butterfly Valve
80mm/3"	2.3 m	1.3 m	0.6 m	3.5 m
100mm/4"	3.1 m	1.6 m	0.8 m	4.6 m
150mm/6"	4.6 m	2.5 m	1.2 m	6.9 m
200mm/8"	6.1 m	3.2 m	1.6 m	9.1 m
250mm /10"	7.7 m	4.1 m	2.0 m	8.9 m
300mm/12"	9.1 m	4.9 m	2.4 m	10.6 m

Equivalent Length of Straight Pipe created by Pipe Fittings

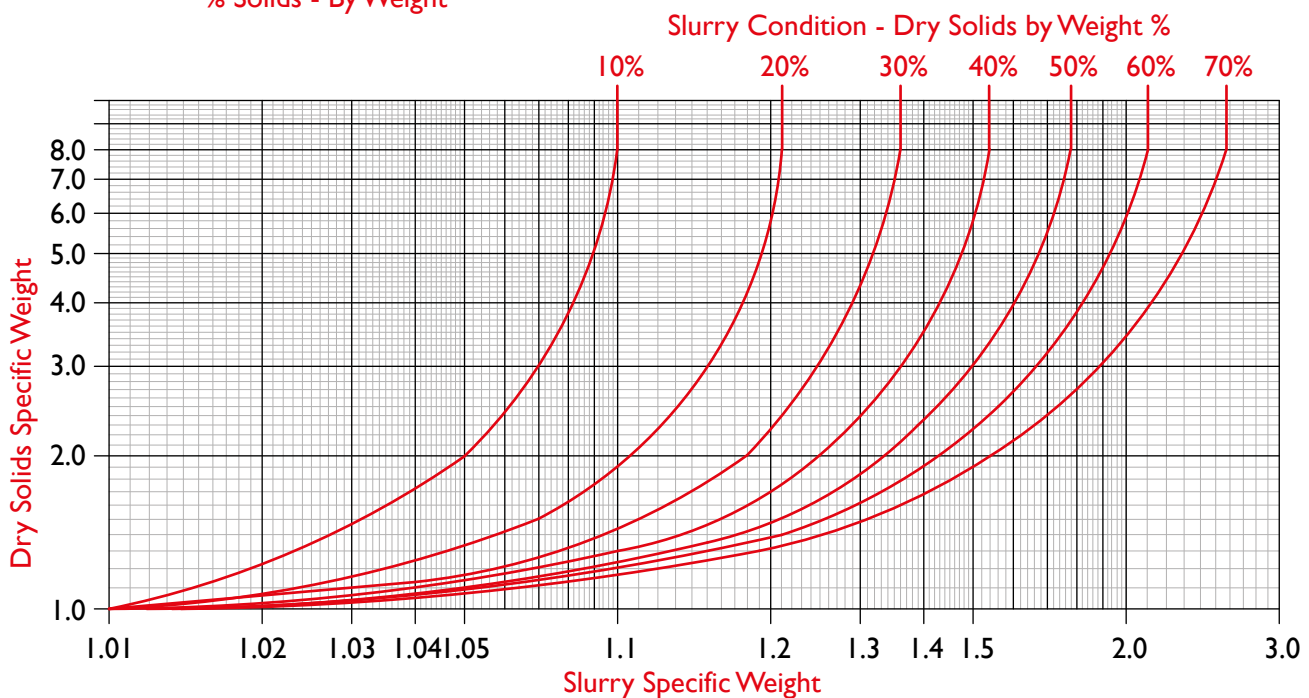

'On-site' Information

Field Estimation of Discharge Rate from Open Ended Pipes

Horizontal Distance 'X' mm	Ø D (Pipe Diameter)									
	2"	2.5"	3"	4"	5"	6"	8"	10"	12"	
	50 mm	65 mm	80 mm	100 mm	125 mm	150 mm	200 mm	250 mm	300 mm	
200	11	19	26	46	71	103	183	285	410	m ³ /h
250	14	24	32	57	89	128	228	356	513	m ³ /h
300	17	29	39	68	107	154	274	428	616	m ³ /h
400	23	39	51	91	143	205	365	570	821	m ³ /h
500	28	48	73	114	178	257	456	712	1026	m ³ /h
600		58	88	137	214	307	547	855	1231	m ³ /h
700			102	160	250	359	638	998	1437	m ³ /h
800			117	183	285	410	729	1140	1642	m ³ /h
900			131	206	320	462	821	1283	1847	m ³ /h
1000				228	356	513	912	1425	2053	m ³ /h
1100				250	392	565	1003	1568	2258	m ³ /h

The dark grey shaded area is the advised minimum flow to maintain a pipeline velocity 2m/s

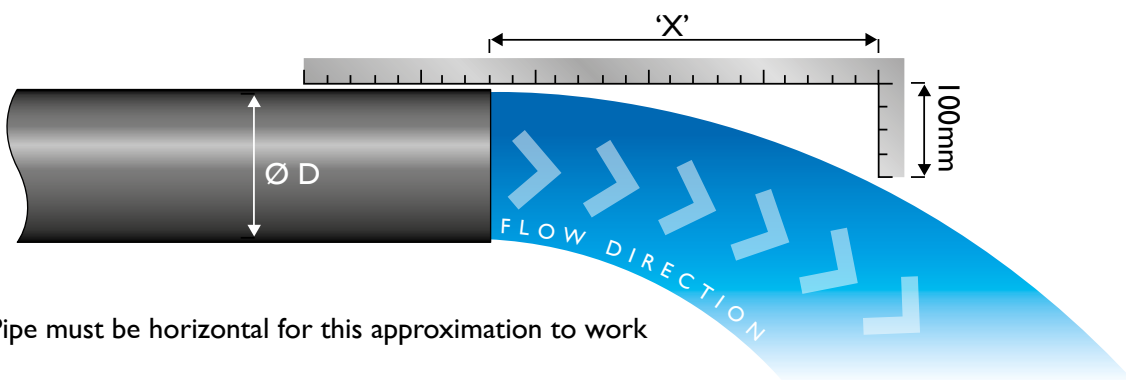

Pipe must be horizontal for this approximation to work

Example: If distance 'X' is 400mm and the discharge pipe used is $\varnothing 100$ mm, then the flow from the pump will be approximately 91 m³/h.

Pump Size	Power kW	Speed RPM	Weight kg	Dimensions mm					Outlet Dia. mm	Max Particle mm	Max Q m ³ /h	Max H m	Max Sg kg/l
				A	B	C	D	E					
100NZE	30	1450	710	1365	920	385	500	475	100	25	137	33	2.8
100ANZE	30	1450	750	1370	925	385	533	475	100	32	220	38	2.8
100HNZB	30	1450	820	1355	910	385	670	475	100	12	160	60	1.5
150NZE	90	960	1925	1775	1120	490	705	630	150	30	380	25	2.5
150ANZE	90	960	1950	1810	1145	490	705	630	150	35	500	40	2.1
150HNZB	90	1450	1990	1860	1200	490	813	630	150	20	290	62	1.5
200NZE	112	960	2500	1970	1320	595	850	760	200	40	600	27	2.5
200ANZE	112	960	2725	1970	1320	595	940	760	200	40	800	40	2.1
200HNZB	112	1450	2500	1970	1320	595	850	760	200	22	800	65	1.5

All pump designs and information is subject to upgrade and revision.

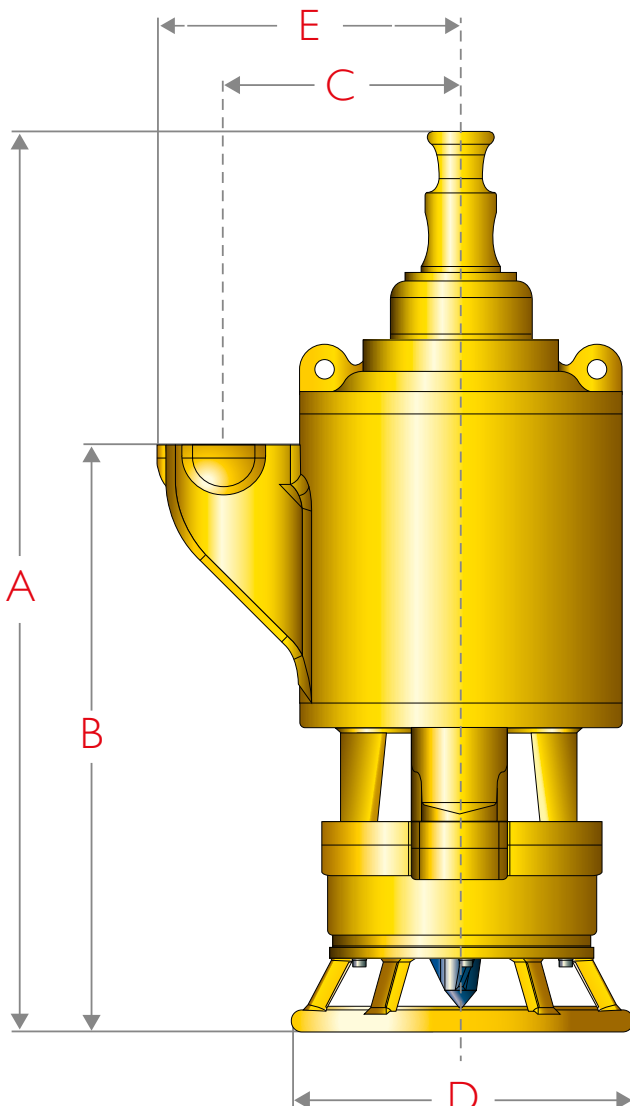

Flange connections

100mm Pump
4" Table 'D'
(Fits 100mm PN10)

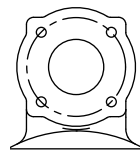

M16*2.0P
4 Places
ø179 PCD

150mm Pump
150mm PN10

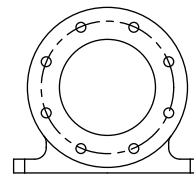

M20*2.5P
8 Places
ø240 PCD

200mm Pump
200mm PN10

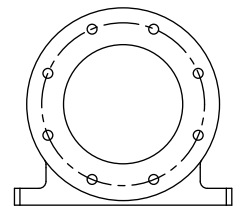

M20*2.5P
8 Places
ø295 PCD

The wet end of the standard pump is made of Type 4 Ni-Hard (ASTM A352 Class I Type D) for its high hardness giving excellent wear life in almost all slurry applications.

For extreme applications, we manufacture a Tungsten Carbide coated variant of this to give extended wear life in Iron Ore, Sand and other abrasive applications.

Fasteners - All fasteners fitted to Goodwin Pumps are supplied in 316 grade Stainless Steel for ease of maintenance.

Best Operating Practice

Correct Installation Example

To ensure that you get the best performance from your Goodwin Submersible Slurry Pump, we recommend that you follow the best practice procedures laid out on these pages.

- Correct sump size - The minimum sump sizes need to be adhered to in order to obtain maximum life from the pump parts and to prevent pipeline blockages. Sump sizes are calculated based on, and are relative to:- pump size, inflow, outflow, sump working capacity and a maximum of 20 pump Stop/Starts permitted in 1 hour. The minimum sump sizes on page 2 are based on pump size and minimum outflow to ensure 2m/Sec velocity in the discharge pipe and pumping cycles repeated every 10 mins.

Example of how to size a sump

Pump Size Selection		100mm			150 mm			200 mm		
Min Sump Size l x w x d (m) - see page 2		2 x 1.5 x 2			2.5 x 2 x 2.5			3 x 2.5 x 3		
Pipe Size mm		100			150			200		
Min outflow for Pipe Velocity 2m/Sec		55			130			230		
Actual Sump Size in (m)		l	w	d	l	w	d	l	w	d
Total Sump Capacity = l x w x d (m ³)		A	6.0		12.5		22.5			
Actual outflow of Pump (l/s)		B	28		61		125			
Sump Free Board depth (m) - Variable according to conditions		C	0.7		0.7		0.7			
Sump Dead Zone see page 2 (m)		D	0.35		0.4		0.45			
Sump working Capacity = A-(C x l x w)-(D x l x w) (m ³)		E	2.9		7.0		13.9			
Sump Inflow (l/s)		F	5.5		14		31			
Time to fill sump from empty (Minutes) = E / (F/60)		G	8.6		8.4		7.6			
Complete cycle time - pumping and resting (Minutes) = (E / ((B-F)/60)) + G Answer Must be >10			10.7		10.9		10.0			

If assistance is needed for sump sizing, please contact your local representative

- A good water to slurry ratio
- Sump level control - If the sump empties, the pump should switch itself off via the automatic control panel. The pump will switch on via a float switch or timer when the level rises.
- Pump should not exceed 20 starts per hour.
- The pump should be suspended by chains at least 200mm from base of the sump to ensure maximum concentration of solids pumped.

Power Supply & Servicing

Always ensure that the pump is correctly connected and protected by using the Goodwin Fully Automatic Control System which has Earth Fault Leakage Protection.

The pump should be inspected as per the recommendations in the operating and maintenance manual.

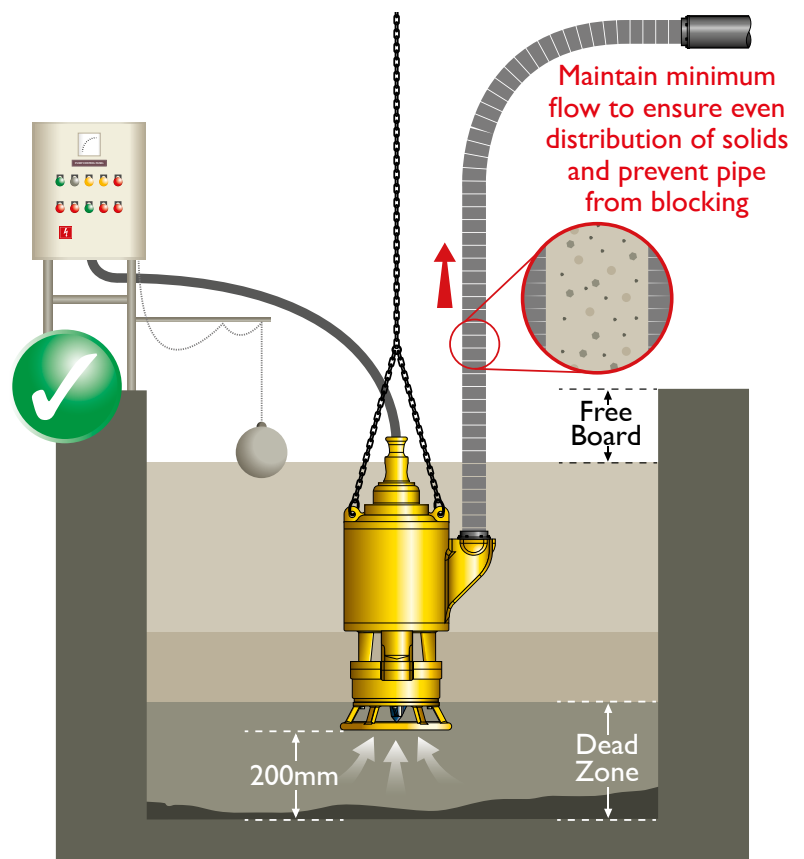
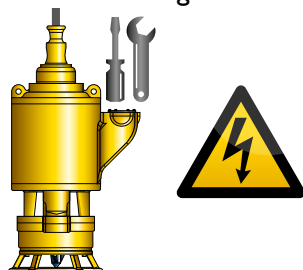

Incorrect Installation Examples

Correct Lifting

When moving or suspending the pump, always use certified lifting equipment. Never lift or suspend the pump using the power cable.

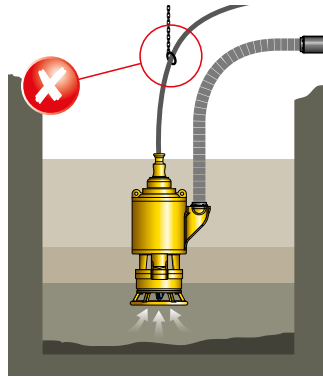

Vertical Positioning

For the best operation of the pump and inducer, ensure that the pump is suspended in a vertical position.

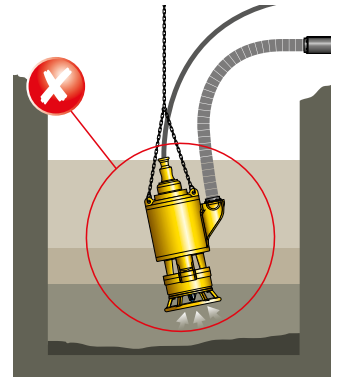

Pump Positioning

When pumping heavy slurries, always suspend the pump with the certified lifting equipment 200mm minimum above the bottom of the sump. Do not let the pump sit on the bottom of the sump.

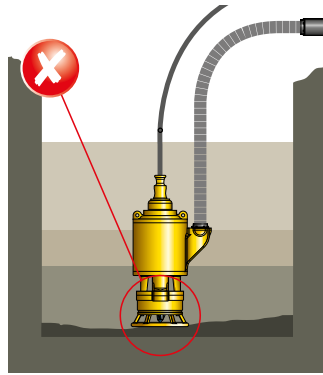

Cable Protection

Make sure that the cable cannot be damaged by the rotating shaft by not allowing too much cable to be released into the slurry.

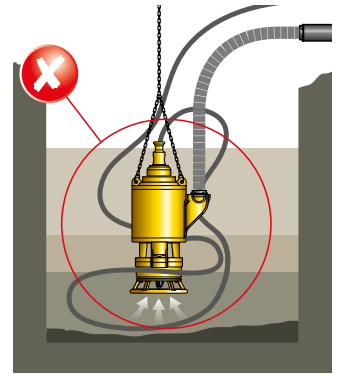

Heavy Duty Flexible Hose Usage

Always use heavy duty flexible hose on the pump discharge. The flexibility of the hose will allow the pump to move on start-up. Do not connect the pump directly to a rigid pipe.

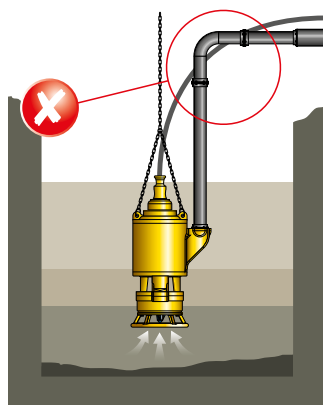

Small Sumps

A small sump will lead to excessive wear and blocked pipes. This is because the pump will quickly evacuate the slurry from the sump until it is snoring (sucking in air with the slurry). As soon as it starts to snore, the flow in the pipe stops as the velocity reduces to zero.

With no velocity in the pipe, all the heavy slurry particles settle out and fall back down the pipe, to the pump's impeller. If the pump is not switched off this leads to rapidly exaggerated wear, grinding the particles rather than pumping them.

If a small sump is continually filling with slurry, there would be a need to exceed the maximum number of starts per hour or to leave the pump running on snore - neither of which are recommended, as by starting too frequently the motor will burn out, and by leaving the pump running, the 'Wet-End' will wear out very quickly as it is grinding and not pumping.

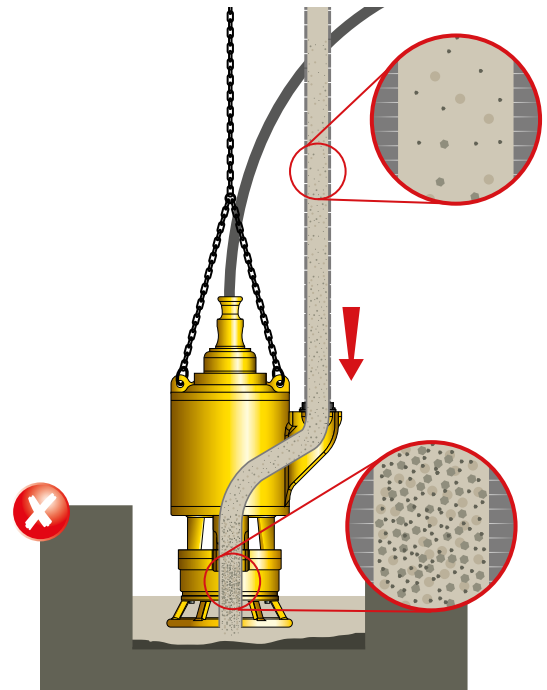

High Head Dewatering

Goodwin DWHH (Dirty Water High Head) Submersible Pump

The Goodwin DWHH pump benefits from many of the Submersible Slurry Pumps unique advantages, making it one of the most versatile pumps in the world.

These features include Forced Convection Cooling, Oil Filled Motor (all Brass & Copper), Non-pressurised Mechanical Seal, Twin Volute Casing, Over-sized Bearings, Extreme Heavy Duty Cable, Product Temperatures up to 90°C, Dry Running Capability for extended periods of time

Many typical uses for the Goodwin DWHH pump include;

- High wall pumping (open pit) applications
- Construction of Buildings, Dams & Harbour walls
- Long distance pumping applications (up to 4 km)
- Agriculture - Irrigation / Centre Pivots, Dam Feeding
- Underground Mining (Non-Explosive applications) - Shaft bottom to first level
- Flood level control - Industrial, Municipal, Mining & Marine
- Emergency and Environmental control

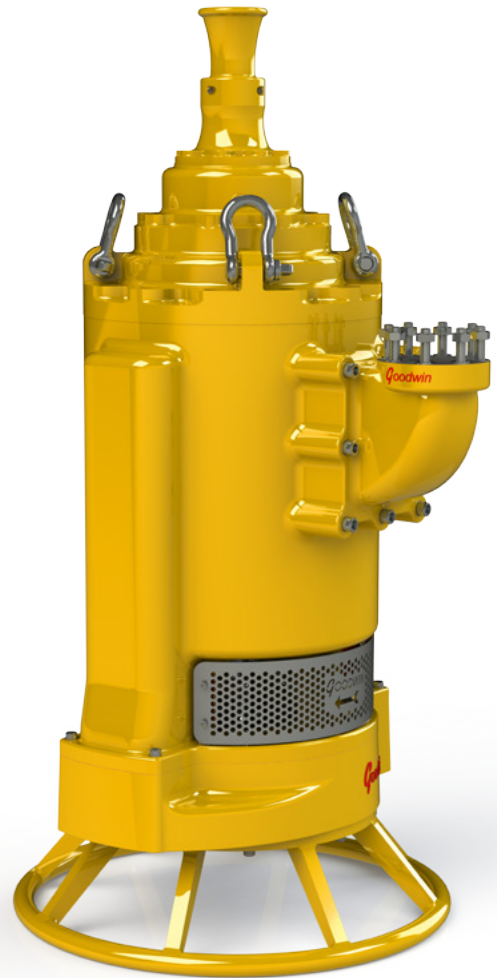

Goodwin Twin Volute Casing Technology

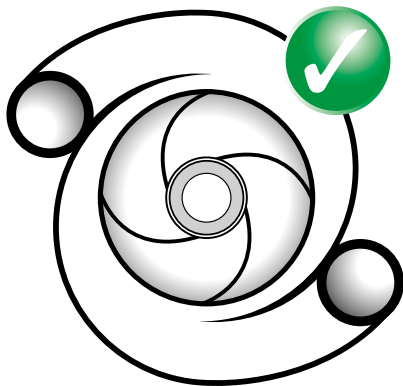

- Max solid content - 5%
- Max specific gravity kg/l - 1.1
- Max particle size - 10mm
- Max product temperature - 90°C
- Max flow m³/hr - 215
- Max head - 130m
- Max pressure - 13 bars
- Max submergence depth - 28m
- Minimum sump size* - L 2.5m x W 2m x D 2.5m
- Sump Dead Zone* (Bottom) - 0.42m

* See page 13 for details

Goodwin DWHH - Technical Information

Electrical Data

Volts	Full Load Current	Inrush Current Direct on line	Inrush Current Soft Start	No Load Current	Fuse Size (HRC)
-------	-------------------	-------------------------------	---------------------------	-----------------	-----------------

90kW , 1450RPM - DWHH

380V	165 A	860 A	580 A	39 A	350 A
415V	156 A	810 A	545 A	37 A	350 A
525V	124 A	645 A	435 A	29 A	300 A
660V	94 A	490 A	330 A	22 A	300 A

DWHH Flange Connections

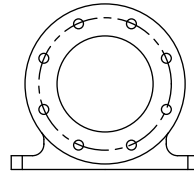

PNI6 - DNI100
M16*2.0P
8 Places
ø180 PCD

Weights & Dimensions

Pump Size	Power kW	Speed RPM	Weight kg	Dimensions mm					Outlet Dia. mm	Max Particle mm	Max Q m³/h	Max H m	Max Sg kg/l
				A	B	C	D	E					
100DWHH	90	1450	1940	1900	1200	500	940	605	100	10	215	130	1.1

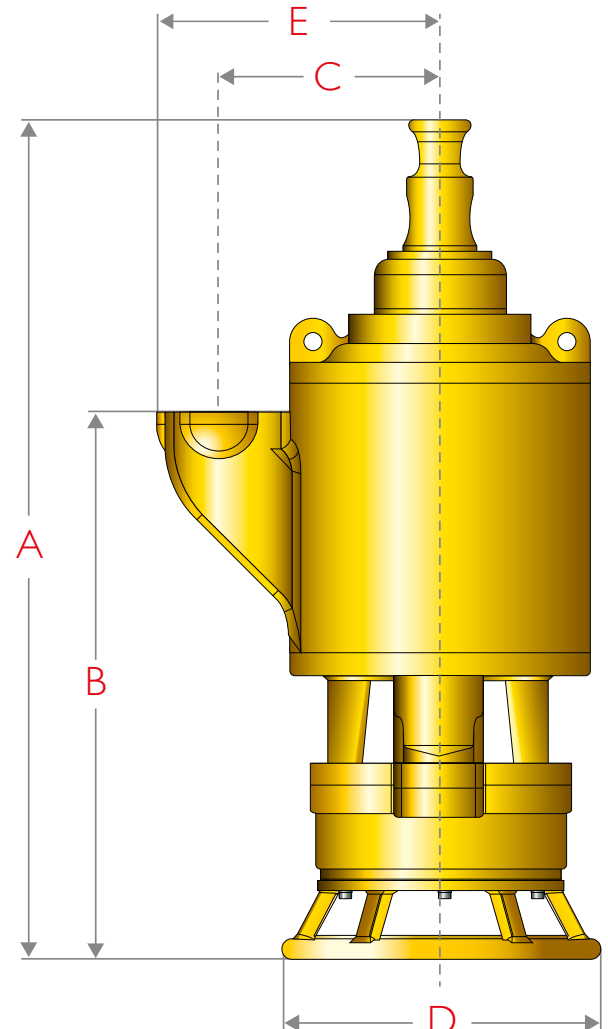
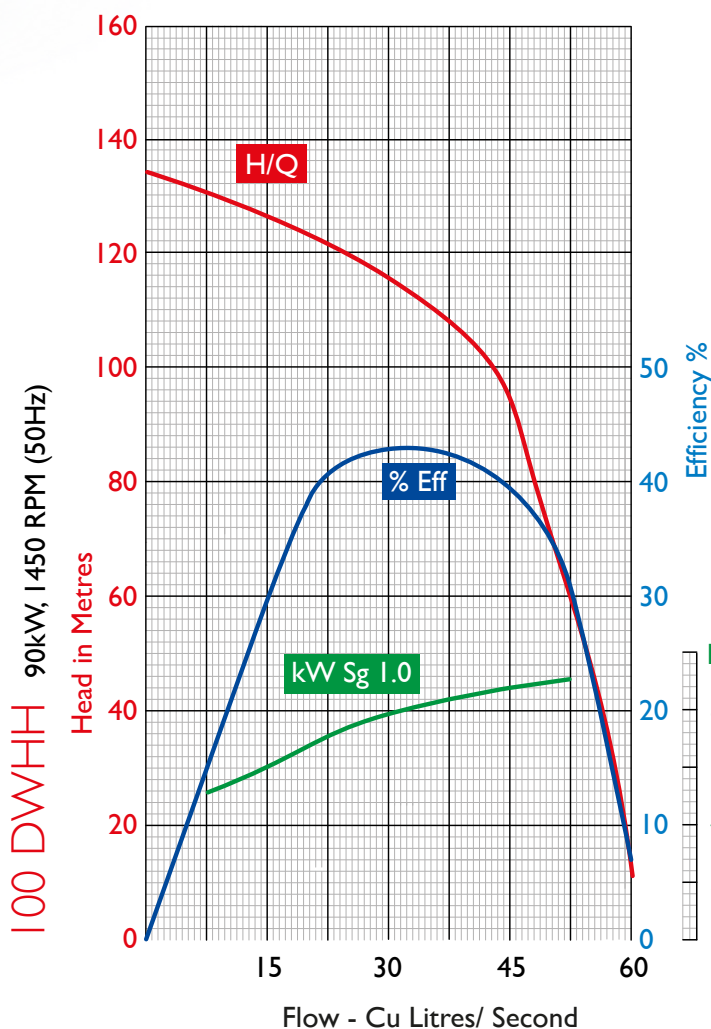

Accessories

Pump Control Panel

The Goodwin fully automatic control panel has four main modes of operation:

- 1 **Manual mode**
The operator can Start and Stop the pump as required.
- 2 **Automatic with Float switch start**
When the high level float switch is activated, the pump will start. When the low current relay senses the drop in power, the pump will stop.
- 3 **Automatic with Timer start**
When the "Start Timer" is energised (user defined time), the pump will start. When the low current relay senses the drop in power, the pump will stop.
- 4 **Automatic with Float switch & Timer start**
In this mode, both the high level float switch and the start timer are used. This means that at a pre-determined time the pump will start, but if the slurry level becomes high before this time, the pump will start. When the low current relay senses the drop in power, the pump will stop.

All Goodwin control panels protect against;

- Earth leakage faults - damage to the cable or pump
- Current overload - of the pump
- Phase imbalance - voltage variation of the incoming supply phases
- Phase rotation - to ensure the pump runs in the correct direction
- Phase loss - the loss of one or more of the incoming phases
- Under voltage - if the incoming voltage is too low
- Over Voltage - if the incoming voltage is too high



30kW Pump Control Panel



90 & 112kW Pump Control Panels

Control Panel Weights & Dimensions

	100mm Pumps	150mm Pumps	200mm Pumps
Weight	45kgs	100kgs	100kgs
Height	Panel Height 600mm Beacon Height 120mm Total Height 720mm	Panel Height 1000mm Beacon Height 120mm Total Height 1120mm	Panel Height 1000mm Beacon Height 120mm Total Height 1120mm
Width	600mm	800mm	800mm
Depth	Panel Depth 200mm Bracket Depth 75mm Total Depth 275mm	Panel Depth 400mm Bracket Depth 75mm Total Depth 475mm	Panel Depth 400mm Bracket Depth 75mm Total Depth 475mm

The benefits of using a Goodwin fully automatic control panel:

- The panel can operate in “Manual” mode, where the operator can Start and Stop the pump as required.
- When used in “Automatic” mode, it extends the life of the pumps wearing parts, as it will not be left running on snore (running but not pumping) for extended periods of time. The Goodwin panel does this by using an electronic low current relay, which detects when the pump is running on a light load (i.e. Snore).
- Before starting, a Xenon beacon flashes and an audible (100Db) alarm sounds to warn operatives.
- The panel is fitted with a lockable isolator” for safe maintenance.
- The panel has the facility to be connected to a “Remote” Start / Stop station, including an Emergency Stop.
- The 90kW & 112kW panels can be supplied for either “Direct-On-Line” starting, or with “Soft Start”. All 30kW panels are designed for “Direct-On-Line” starting.
- All panels are IP65 rated as standard, and are suitable for both indoor and outdoor use.
- All panels are fitted with rear mounting brackets as standard.

Optional accessories for your Goodwin fully automatic control panel

- Control panel stand
- Control panel hood

Wet End Spares Kit

To assist our customers, Goodwin have developed a ‘Wet-End’ spares kit which includes all of the necessary items your technicians will need to perform essential periodic maintenance on your Goodwin pump, to ensure reliable operation and the long life of your investment.

The spares kit includes an Impeller, Wear Plate, Inducer, Shaft Sleeve, Lock Nut, Spacers, Fasteners - plus all of the tools and lubricants needed to perform the task and a step-by-step guide.



Pontoons

For the 100mm range of pumps, Goodwin can offer its bespoke modular pump pontoon and winch system. This allows the user to easily manoeuvre their pump to where it is needed, without the ongoing expense of hiring a crane. The pontoon is supplied in “kit” form for ease of transportation, and can be fully assembled in just a few hours.



GOODWIN[®]

SUBMERSIBLE PUMPS AUSTRALIA

Head Office

Brisbane Sales Office and Service Centre
Goodwin Submersible Pumps Australia P/L
6/18 Hinkler Court,
Brendale,
QLD 4500
AUSTRALIA

Phone: +61(0)7 3205 7860

Email: sales@goodwinaustralia.com.au

Postal Address
PO Box 5519
Brendale DC,
QLD 4500
AUSTRALIA

www.goodwinaustralia.com.au

Sales Office

Perth Sales Office
PO Box 88,
Osborne Park,
WA 6017
AUSTRALIA

Phone: +61(0)8 6365 4861